

Živi siguran život uz WINPER

www.winper.ba

Adresa : Rakovička cesta 104 Sarajevo / BiH
Telefon : +387644488477
Fax : +387644488477
Fabrika : Modern San. Sitesi Yeşiltepe Mah.
8030 Sok. No:12 Erenler / Sakarya
Telefon : +90 264 276 91 33
Fax : +90 264 276 91 33
Email : info@winper.ba
Web : www.winper.ba

WINPER

1975

PVC I ALU STOLARIJA

- Klizni Stakleni Sistemi

Sistemi kliznog stakla

Zahvaljujući širokim staklenim panelima na vašim balkonima, možete stvoriti maksimalnu vidljivu površinu.

Sa svojom jednostavnošću upotrebe i niskom strukturom praga, savršeno je rješenje za zimske bašte i kancelarijske pregrade.

Ovisno o vašim željama za jednostruko ili dvostruko staklo, možete podesiti izolaciju unutar optimalnih vrijednosti na vašem balkonu ili zimskom vrtu.

Estetski

Zahvaljujući detaljima tankog profila, ne smanjuje vašu svjetlost . Zahvaljujući niskoj visini praga, nudi mogućnost primjene na različitim mjestima.

Zvučna i toplotna izolacija

Smanjuje nivo buke upotrebom jednostrukog i dvostrukog stakla. Toplotna izolacija je ojačana upotrebom dvostrukog stakla.

Space Saving

Proširuje vaš životni prostor, dok vam omogućava da uživate na balkonu i vrtu bez obzira na godišnje doba.

Sigurnost

Upotrebom kaljenog stakla smanjuje se rizik od neželjenih nezgoda uz pružanje otpornosti na udarce.

Vista Unico stakleni balkonski sistemi

Svojom preferencijom stakla od 30 mm, pruža mogućnost korištenja zavjesa između dva stakla. Omogućava jednostavnu upotrebu sa svojim posebnim dizajnom ručke i kapacitetom nošenja.

Dizajn i funkcionalnost

- Sistem, koji ima 8 nosećih točkova na svakom krilu, omogućava jednostavnu upotrebu.
- Staklene ploče u sistemu Vista Unico Sliding Glass Balcony; mogu se sakupljati odvojeno sa obe strane. Zahvaljujući ovoj osobini, istovremeno stvarajući jednostavnost korištenja u područjima gdje se primjenjuje, stvara neprekidan pogled.
- Sa gornjom bravom postavljenom u Camoda Vista Unico kliznom staklenom balkonskom sistemu, spriječen je prolaz vjetra i prašine u unutrašnjost. Na taj način se stvara udoban camo životni prostor.
- Sistemi zaključavanja u Vista Unico Sliding seriji su montirani na željenoj visini na vertikalnoj osi, stvarajući ergonomsku upotrebu.

Izolacija

- Otpornost na vjetar je ojačana zahvaljujući kanalima za brtvljenje četkica na profilima krila u Camoda Vista Unico kliznom staklenom balkonskom sistemu.
- Zahvaljujući dvostrukom redu brtvi četkica koji se koriste okomito, smanjuje utjecaj vanjskih faktora i stvara miran prostor pogodan za sva godišnja doba za korisnika.
- Zahvaljujući aluminijskom zaptivnom profilu i primjeni kaljenog dvostrukog stakla, istezanje stakla i prolaz zraka su minimizirani i obezbjeđuje se sigurno i izolirano okruženje.

Sigurnost

- Camoda Vista Unico klizni stakleni balkonski sistem stvara sigurno okruženje od vanjskih intervencija zahvaljujući posebnom mehanizmu za zaključavanje koji se može zaključati i iznutra i izvana.





KLIZNI Stakleni

SLIDING GLASS SYSTEM

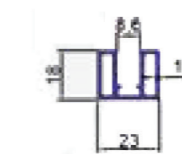
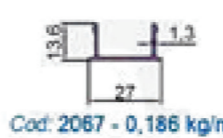
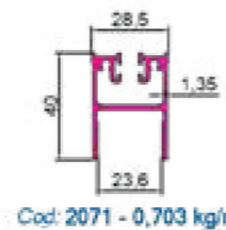
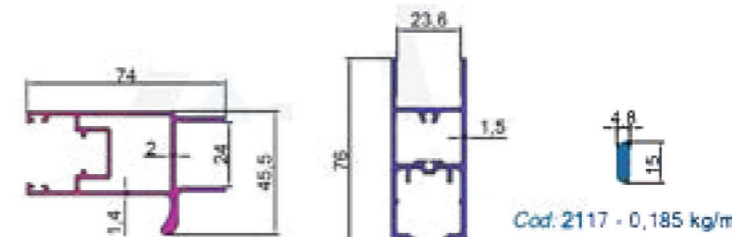
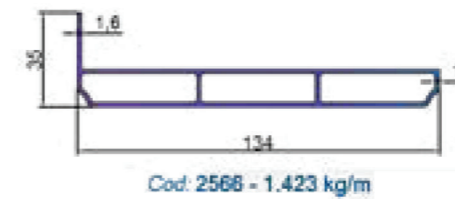
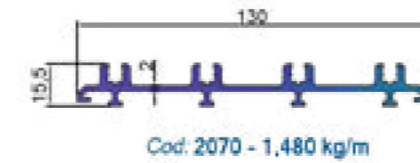
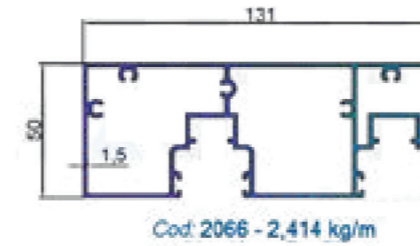
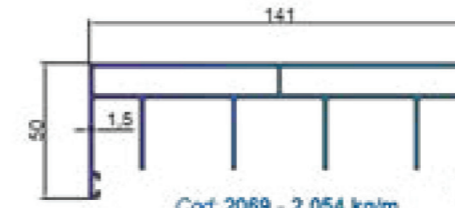

FOUR SYSTEM SECTION

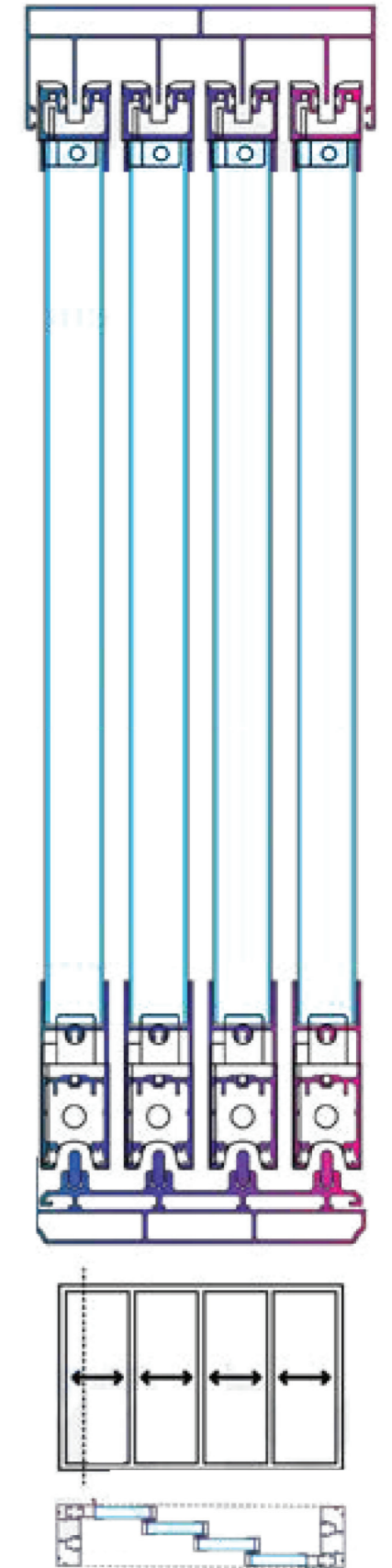

BINARY SYSTEM

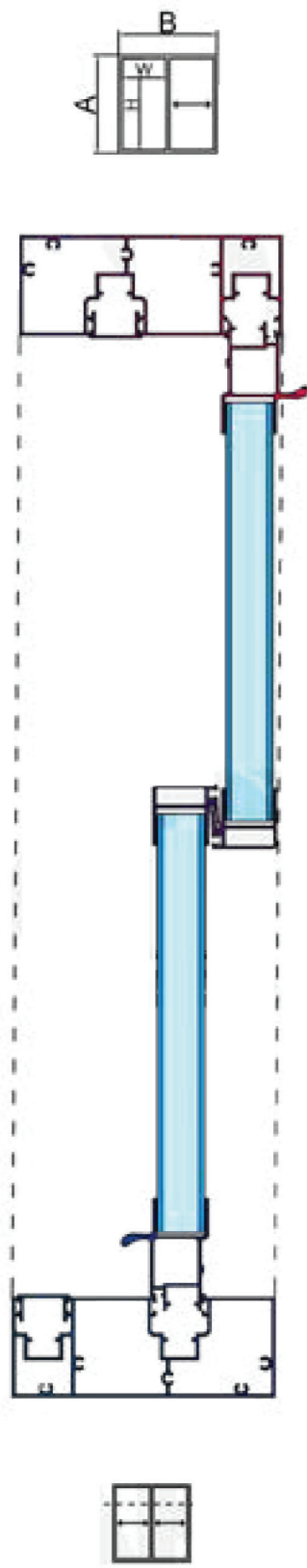

TRIPLE SYSTEM

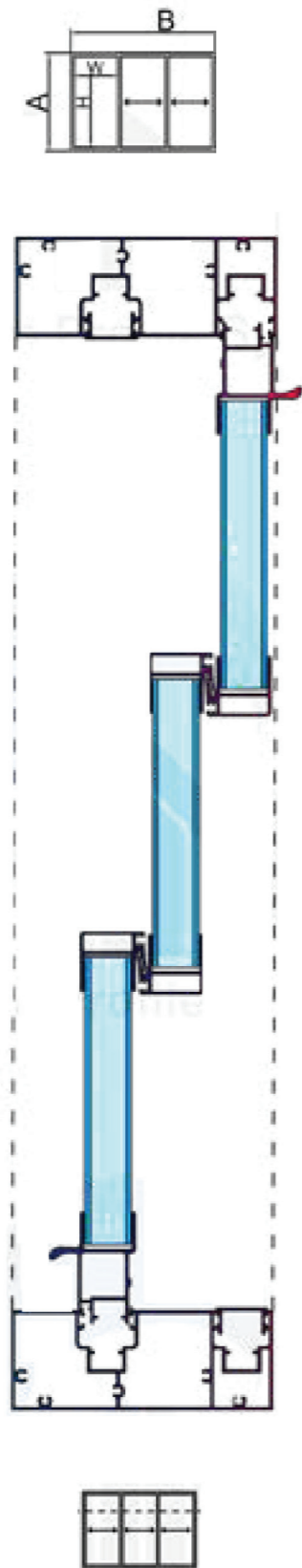

QUATERNARY SYSTEM

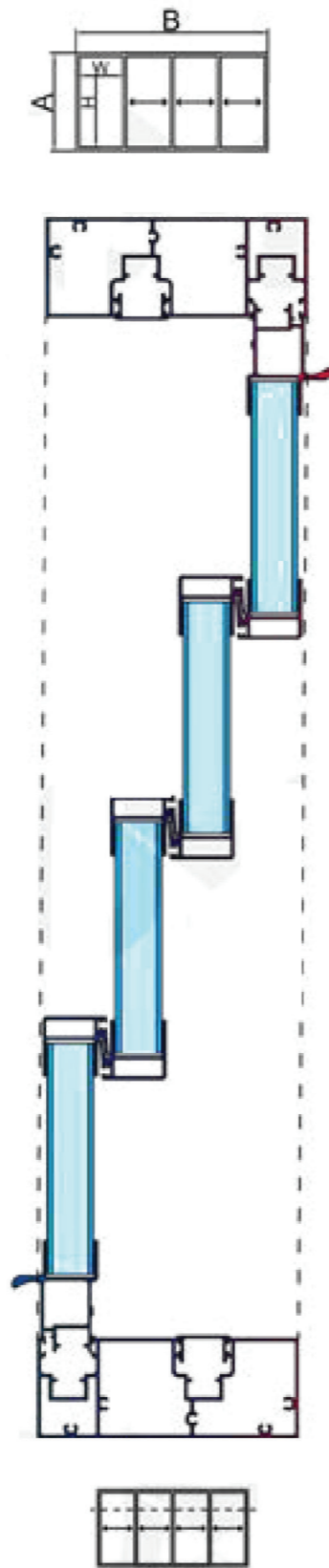

QUINTET SYSTEM

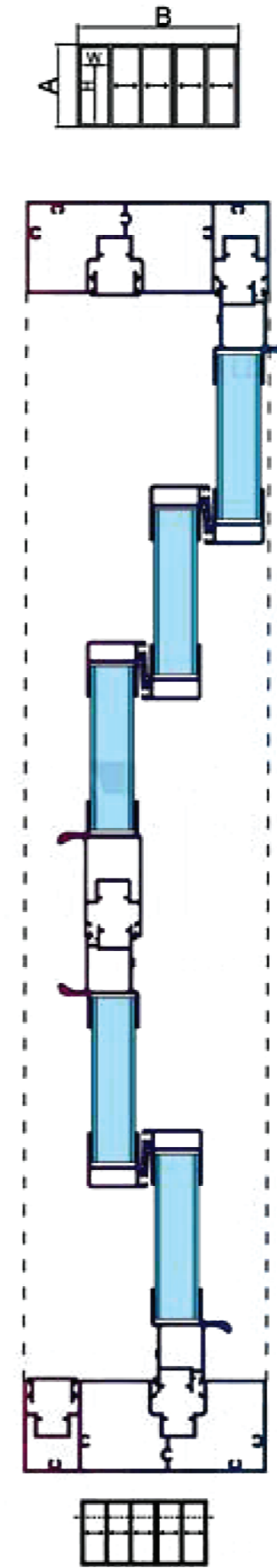

SIX SYSTEM

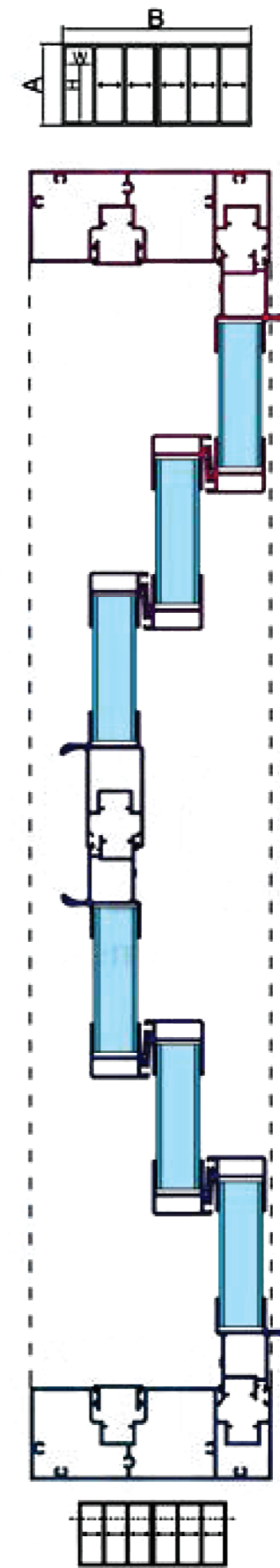

A modern building facade featuring a large glass window system with dark frames. The building has a light-colored stone or brick upper section and a wooden slat lower section. A wooden deck is visible in the foreground. A green banner is overlaid on the right side of the image, containing the text 'KLIZNI Stakleni' in white. The text 'KLIZNI' is in a simple, uppercase sans-serif font, and 'Stakleni' is in a white, elegant cursive script font.

KLIZNI
Stakleni

SEVEN SYSTEM

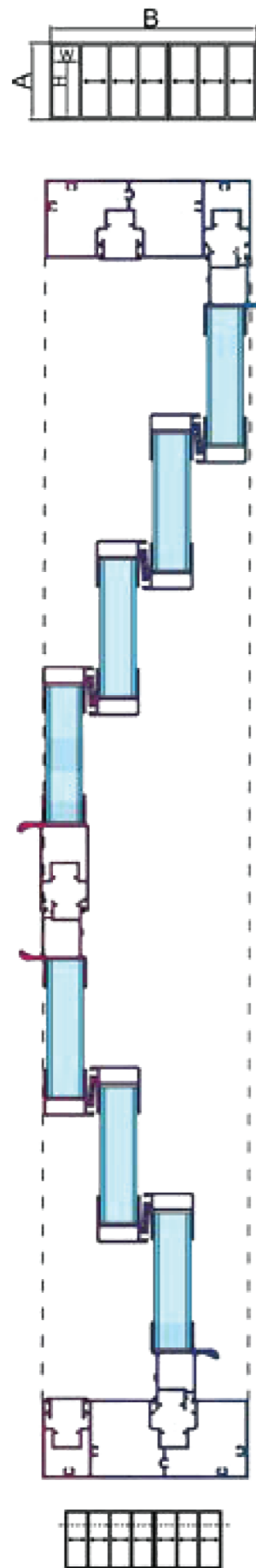

OCTAL SYSTEM

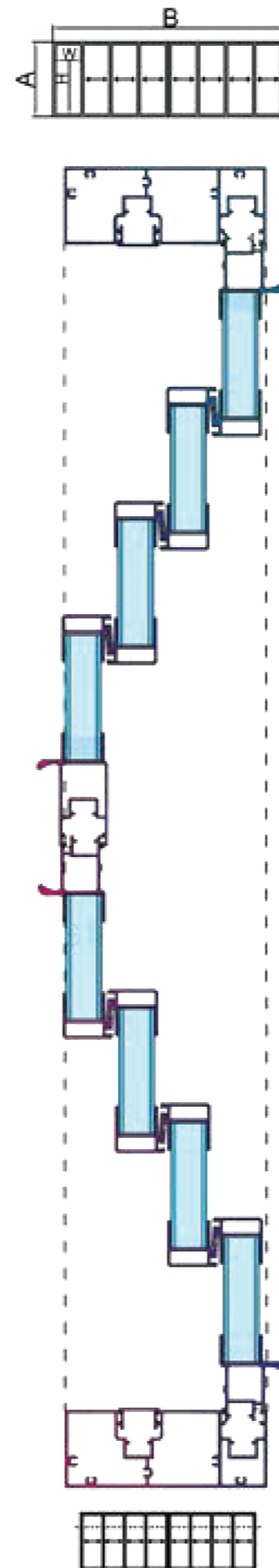

Side Sash Profile
 Product Code: 2066
 Weight kg/m: 2,414
 (50 x 131 x 1,5mm)

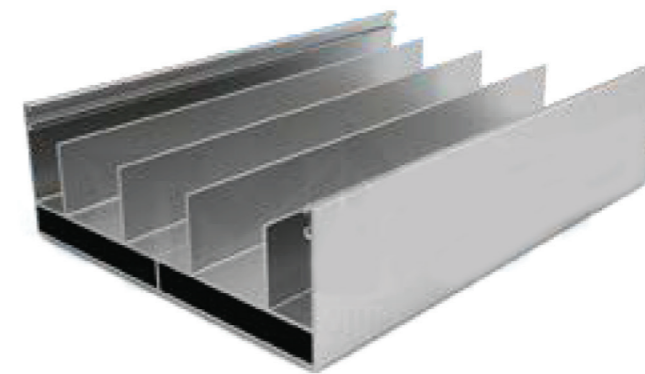

Upper Sash Profile
 Product Code: 2069
 Weight kg/m: 2,054
 (50 x 141 x 1,5mm)



Bottom Sash Profile
 Product Code: 2070
 Weight kg/m: 1,480
 (15,5 x 130 x 2mm)

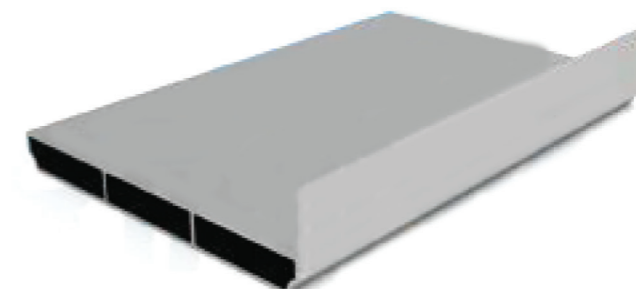

Lower Base Profile
 Product Code: 2566
 Weight kg/m: 1,423
 (35 x 134 x 1,6mm)



Two System Connection Profile

Product Code: 2149

Weight kg/m: 1,160
(45,5 x 74 x 1,4mm)



*Side Frame Profile With Handle
For 22 mm Glass*

Product Code: 2068

Weight kg/m: 0,878
(43 x 56 x 1,5mm)



Cover For Side Sash Profile

Product Code: 2067

Weight kg/m: 0,186
(13,6 x 27 x 1,3mm)

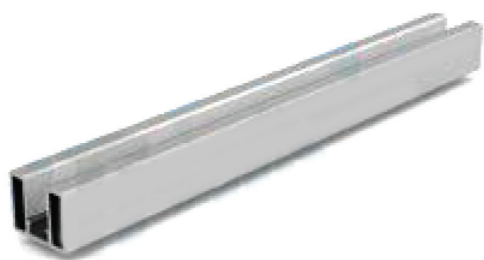

8 mm Glass Convertor Profile

Product Code: 2150

Weight kg/m: 0,375
(18 x 23 x 1,4mm)

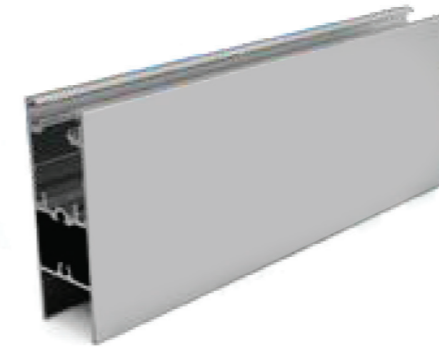

*Bottom Frame Profile
For 22 mm Glass*

Product Code: 2565

Weight kg/m: 1,205
(23,6 x 76 x 1,5mm)



*Upper Frame Profile
For 22 mm Glass*

Product Code: 2071

Weight kg/m: 0,703
(28,5 x 40 x 1,35mm)

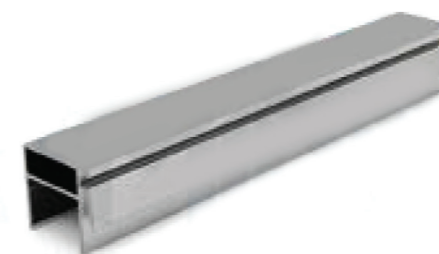

Side Frame Profile For 22 mm Glass

Product Code: 2065

Weight kg/m: 0,585
(30 x 33 x 1,5mm)

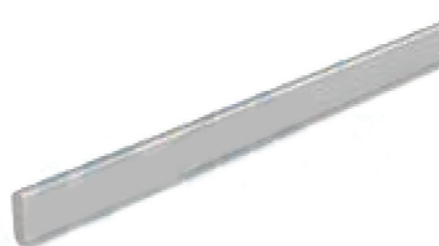

Bottom Sash Profile For Roll

Product Code: 2117

Weight kg/m: 0,185
(4,8 x 15 mm)

SLIDING GLASS SYSTEM



Case Lower Corner Wedge
Product Code: Srm-05
Box Piece: 2



Case Top Corner Wedge
Product Code: Srm-06
Box Piece: 2



Sliding Wheel Double Bottom
Product Code: Srm-07
Box Piece: 8



Arm Wing Top Plastic
Product Code: Srm-08
Box Piece: 2



Arm Wing Lower Plastic
Product Code: Srm-09
Box Piece: 2



Spiked Wing Top Plastic
Product Code: Srm-10
Box Piece: 6



Upper Wheel
Product Code: Srm-11
Box Piece: 16



Spiked Wing Lower Plastic
Product Code: Srm-18
Box Piece: 2



Espagnolette
Product Code: Srm-03
Box Piece: 2



Espagnolette Equivalent
Product Code: Srm-04
Box Piece: 6



Unlocked Handle
Product Code: Srm-12
Box Piece: 1



locked Handle
Product Code: Srm-13
Box Piece: 1

SLIDING GLASS MONTAGE



